



**100V 6.5mΩ N-Ch Power MOSFET**

**Features**

- Ultra-low  $R_{DS(ON)}$
- Low Gate Charge
- 100% UIS Tested, 100%  $R_g$  Tested
- Pb-free Lead Plating
- Halogen-free and RoHS-compliant

**Product Summary**

Parameter	Value	Unit
$V_{DS}$	100	V
$V_{GS(th\_Typ)}$	1.8	V
$I_D$ (@ $V_{GS} = 10V$ ) <sup>(1)</sup>	114	A
$R_{DS(ON\_Typ)}$ (@ $V_{GS} = 10V$ )	6.5	mΩ
$R_{DS(ON\_Typ)}$ (@ $V_{GS} = 4.5V$ )	8.1	mΩ

**Applications**

- Power Management in Telecom., Industrial Automation, CE
- Current Switching in DC/DC & AC/DC (SR) Sub-systems
- Motor Driving in Power Tool, E-vehicle, Robotics

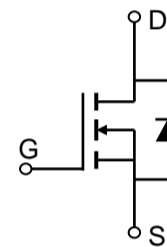
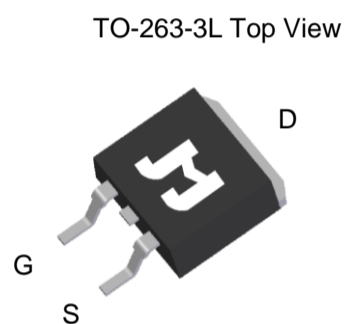
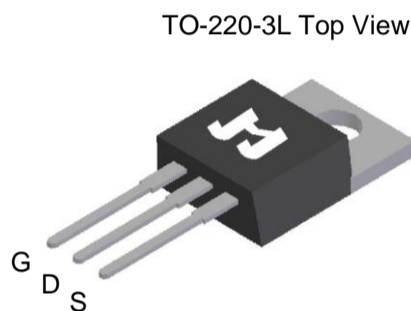

**Ordering Information**

Device	Package	# of Pins	Marking	MSL	$T_J$ (°C)	Media	Quantity (pcs)
JMSL1008AC-U	TO-220-3L	3	SL1008A	N/A	-55 to 150	Tube	50
JMSL1008AE-13	TO-263-3L	3	SL1008A	3	-55 to 150	13-inch Reel	800

**Absolute Maximum Ratings** (@  $T_A = 25^\circ\text{C}$  unless otherwise specified)

Parameter	Symbol	Value	Unit
Drain-to-Source Voltage	$V_{DS}$	100	V
Gate-to-Source Voltage	$V_{GS}$	±20	V
Continuous Drain Current <sup>(1)</sup>	$I_D$	$T_C = 25^\circ\text{C}$	114
		$T_C = 100^\circ\text{C}$	72
Pulsed Drain Current <sup>(2)</sup>	$I_{DM}$	360	A
Avalanche Current <sup>(3)</sup>	$I_{AS}$	42	A
Avalanche Energy <sup>(3)</sup>	$E_{AS}$	88	mJ
Power Dissipation <sup>(4)</sup>	$P_D$	$T_C = 25^\circ\text{C}$	192
		$T_C = 100^\circ\text{C}$	77
Junction & Storage Temperature Range	$T_J, T_{STG}$	-55 to 150	°C

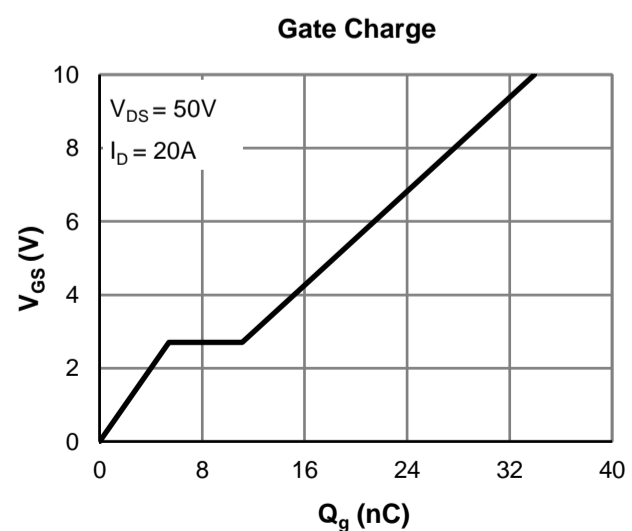
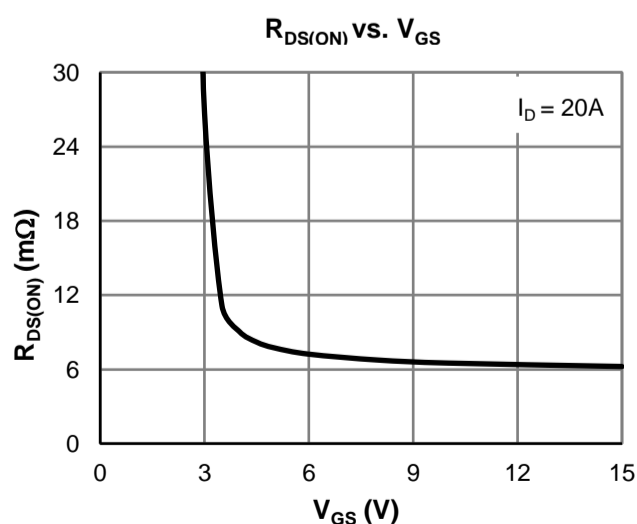



**Electrical Characteristics** (@  $T_J = 25^\circ\text{C}$  unless otherwise specified)

Parameter	Symbol	Conditions	Min.	Typ.	Max.	Unit
<b>STATIC PARAMETERS</b>						
Drain-Source Breakdown Voltage	$V_{(BR)DSS}$	$I_D = 250\mu\text{A}, V_{GS} = 0\text{V}$	100			V
Zero Gate Voltage Drain Current	$I_{DSS}$	$V_{DS} = 80\text{V}, V_{GS} = 0\text{V}$			1.0	$\mu\text{A}$
					5.0	
Gate-Body Leakage Current	$I_{GSS}$	$V_{DS} = 0\text{V}, V_{GS} = \pm 20\text{V}$			$\pm 100$	nA
Gate Threshold Voltage	$V_{GS(th)}$	$V_{DS} = V_{GS}, I_D = 250\mu\text{A}$	1.2	1.8	2.5	V
Static Drain-Source ON-Resistance	$R_{DS(ON)}$	$V_{GS} = 10\text{V}, I_D = 20\text{A}$		6.5	7.8	m $\Omega$
			$V_{GS} = 4.5\text{V}, I_D = 15\text{A}$		8.1	
Forward Transconductance	$g_{FS}$	$V_{DS} = 5\text{V}, I_D = 20\text{A}$		82		S
Diode Forward Voltage	$V_{SD}$	$I_S = 1\text{A}, V_{GS} = 0\text{V}$		0.71	1.0	V
Diode Continuous Current	$I_S$	$T_C = 25^\circ\text{C}$			192	A
<b>DYNAMIC PARAMETERS</b> <sup>(5)</sup>						
Input Capacitance	$C_{iss}$	$V_{GS} = 0\text{V}, V_{DS} = 50\text{V}, f = 1\text{MHz}$		2360		pF
Output Capacitance	$C_{oss}$			368		pF
Reverse Transfer Capacitance	$C_{rss}$			5.9		pF
Gate Resistance	$R_g$	$V_{GS} = 0\text{V}, V_{DS} = 0\text{V}, f = 1\text{MHz}$		1.7		$\Omega$
<b>SWITCHING PARAMETERS</b> <sup>(5)</sup>						
Total Gate Charge (@ $V_{GS} = 10\text{V}$ )	$Q_g$	$V_{GS} = 0 \text{ to } 10\text{V}$ $V_{DS} = 50\text{V}, I_D = 20\text{A}$		34		nC
Total Gate Charge (@ $V_{GS} = 4.5\text{V}$ )	$Q_g$			16.8		nC
Gate Source Charge	$Q_{gs}$			5.4		nC
Gate Drain Charge	$Q_{gd}$			5.7		nC
Turn-On DelayTime	$t_{D(on)}$	$V_{GS} = 10\text{V}, V_{DS} = 50\text{V}$ $R_L = 2.5\Omega, R_{GEN} = 6\Omega$		8.4		ns
Turn-On Rise Time	$t_r$			12.2		ns
Turn-Off DelayTime	$t_{D(off)}$			43		ns
Turn-Off Fall Time	$t_f$			18.9		ns
Body Diode Reverse Recovery Time	$t_{rr}$	$I_F = 15\text{A}, dI_F/dt = 100\text{A}/\mu\text{s}$		49		ns
Body Diode Reverse Recovery Charge	$Q_{rr}$	$I_F = 15\text{A}, dI_F/dt = 100\text{A}/\mu\text{s}$		43		nC

**Thermal Performance**

Parameter	Symbol	Typ.	Max.	Unit
Thermal Resistance, Junction-to-Ambient	$R_{\theta JA}$	45	55	$^\circ\text{C}/\text{W}$
Thermal Resistance, Junction-to-Case	$R_{\theta JC}$	0.55	0.65	$^\circ\text{C}/\text{W}$

**Notes:**

1. Computed continuous current assumes the condition of  $T_{J\_Max}$  while the actual continuous current depends on the thermal & electro-mechanical application board design.
2. This single-pulse measurement was taken under  $T_{J\_Max} = 150^\circ\text{C}$ .
3. This single-pulse measurement was taken under the following condition [ $L = 100\mu\text{H}, V_{GS} = 10\text{V}, V_{DS} = 50\text{V}$ ] while its value is limited by  $T_{J\_Max} = 150^\circ\text{C}$ .
4. The power dissipation  $P_D$  is based on  $T_{J\_Max} = 150^\circ\text{C}$ .
5. This value is guaranteed by design hence it is not included in the production test.

**Typical Electrical & Thermal Characteristics**

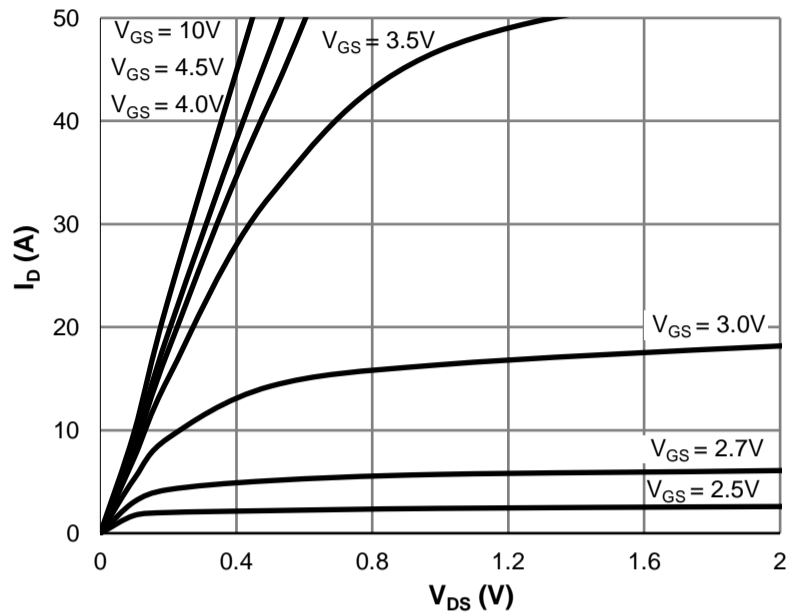

**Figure 1: Saturation Characteristics**

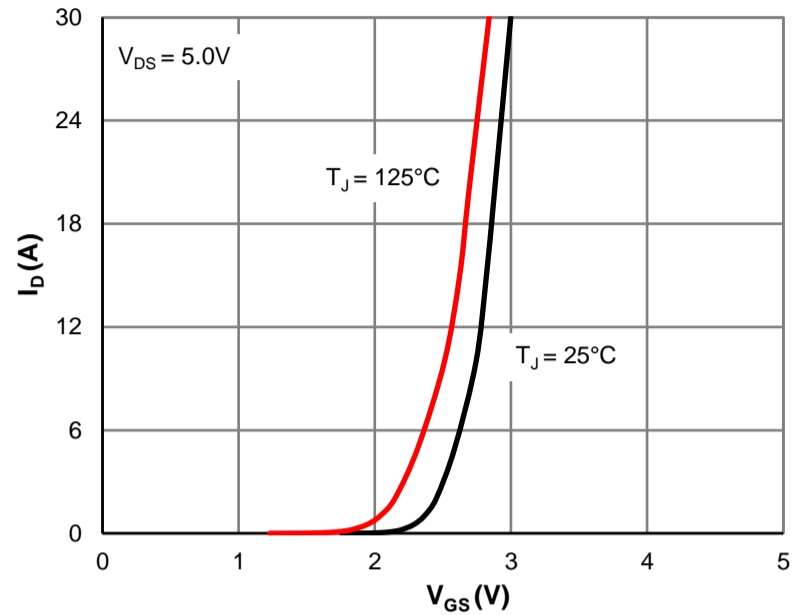

**Figure 2: Transfer Characteristics**

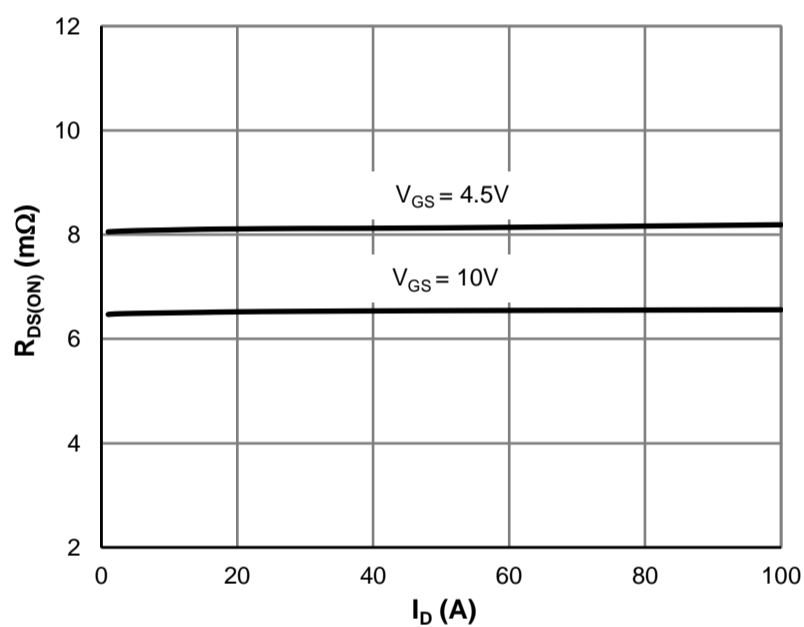

**Figure 3:  $R_{DS(ON)}$  vs. Drain Current**

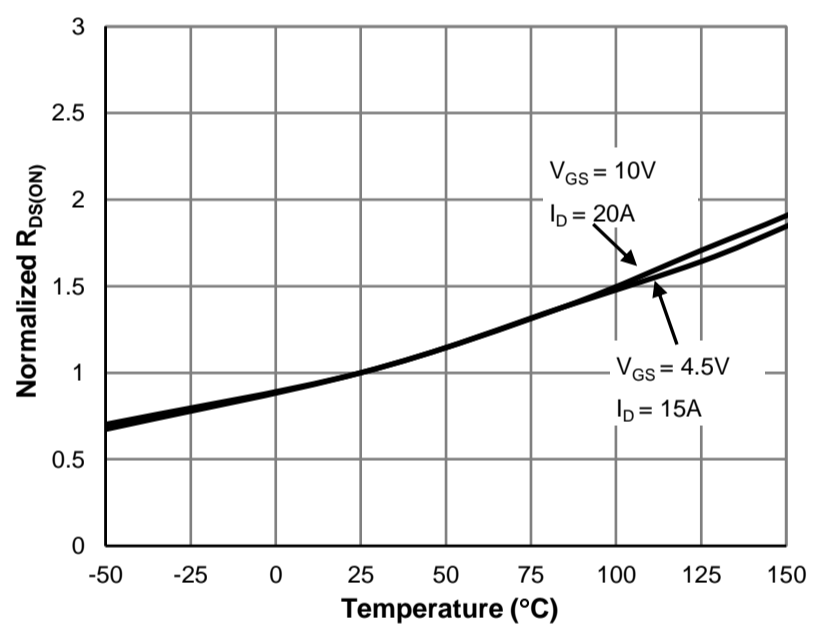

**Figure 4:  $R_{DS(ON)}$  vs. Junction Temperature**

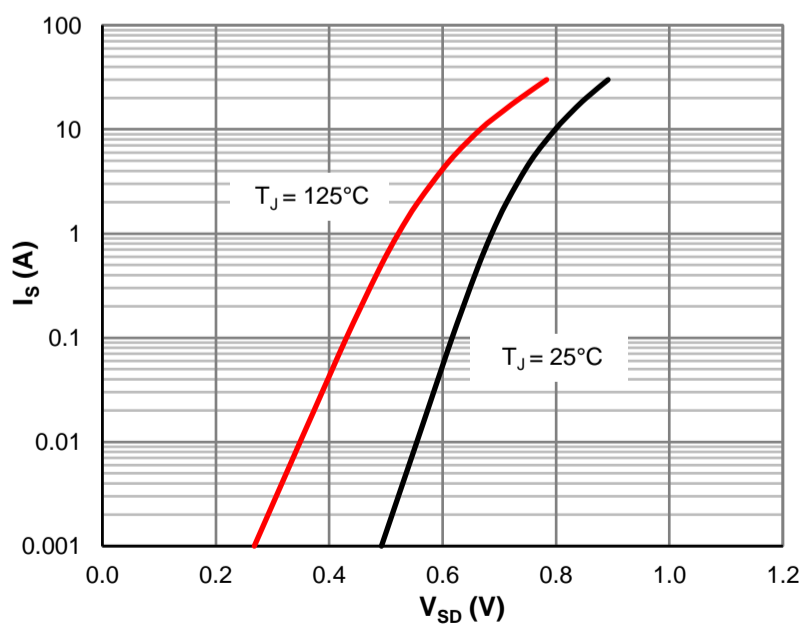

**Figure 5: Body-Diode Characteristics**

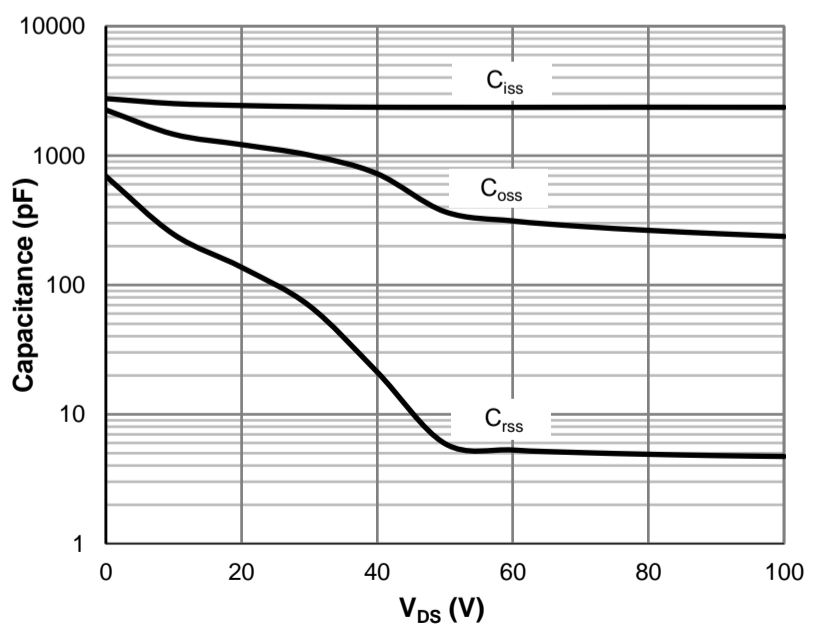

**Figure 6: Capacitance Characteristics**

Typical Electrical & Thermal Characteristics

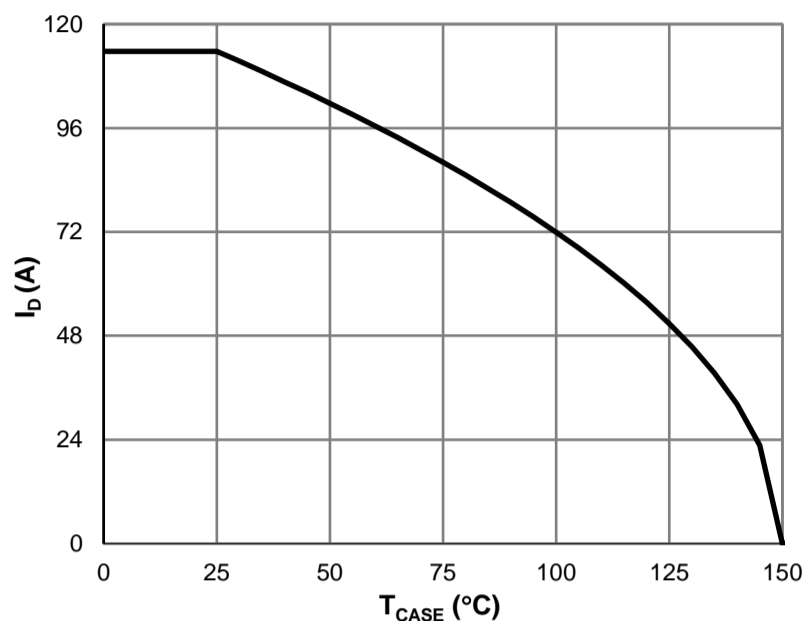

Figure 7: Current De-rating

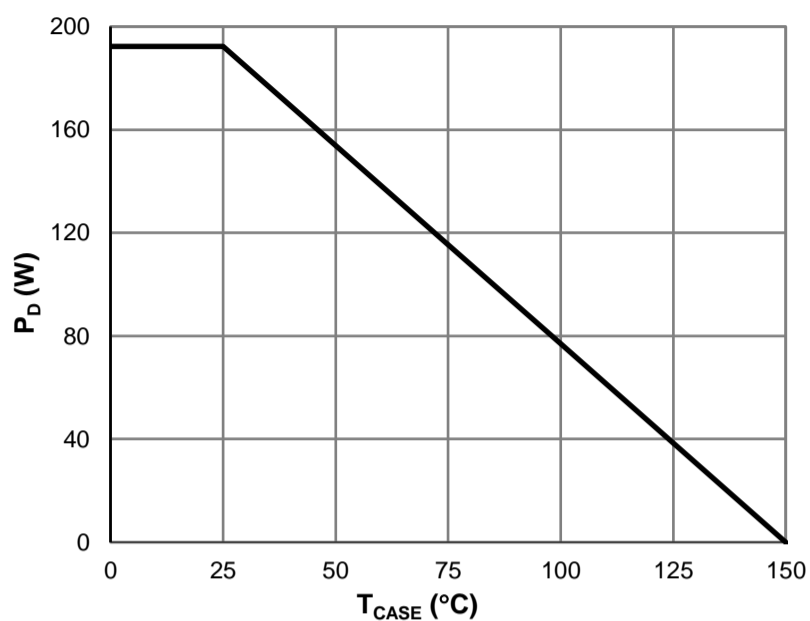

Figure 8: Power De-rating

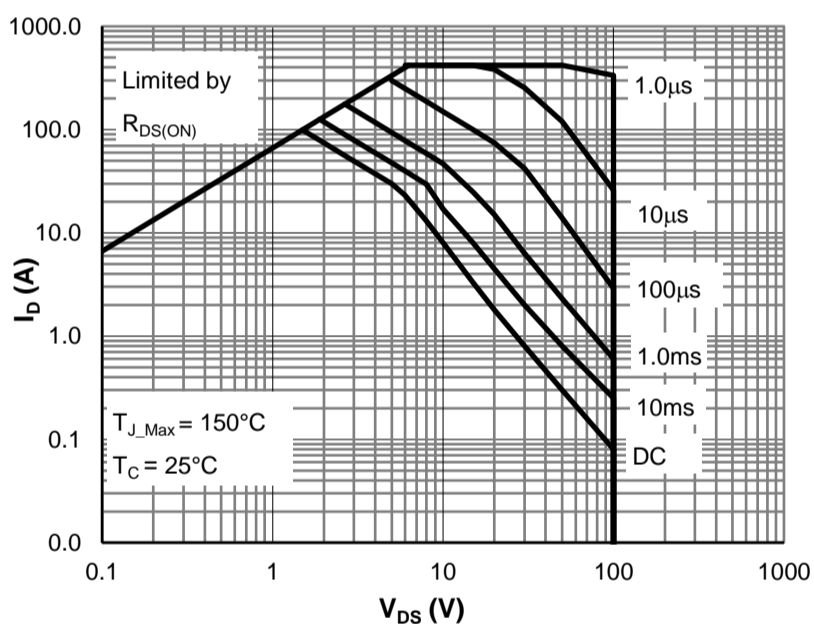

Figure 9: Maximum Safe Operating Area

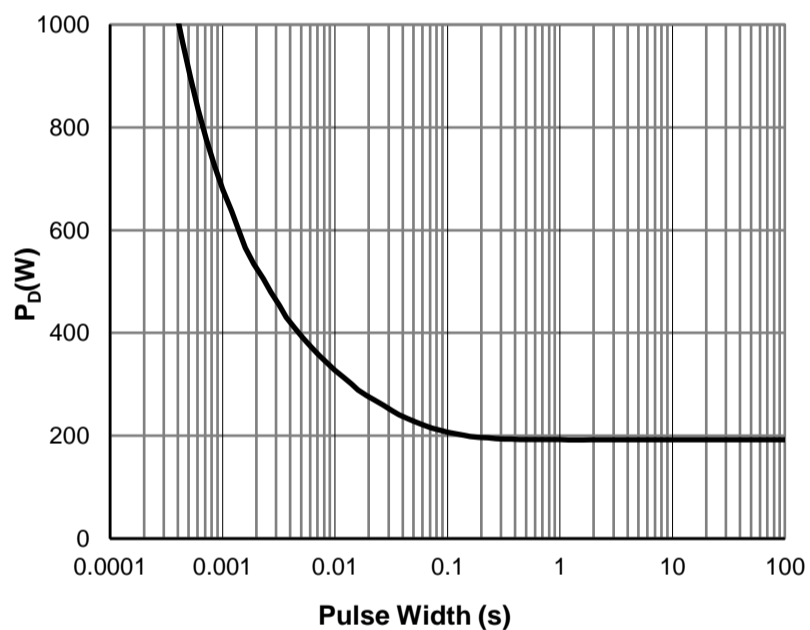

Figure 10: Single Pulse Power Rating, Junction-to-Case

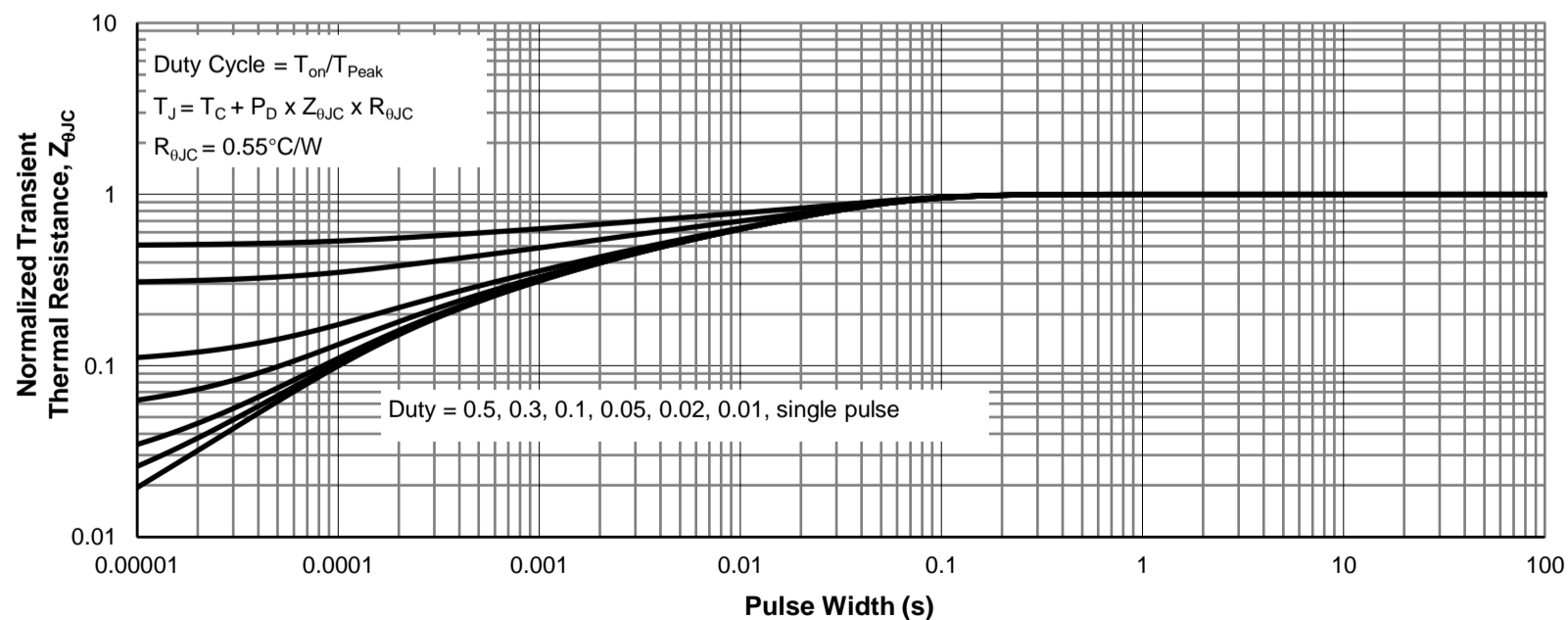
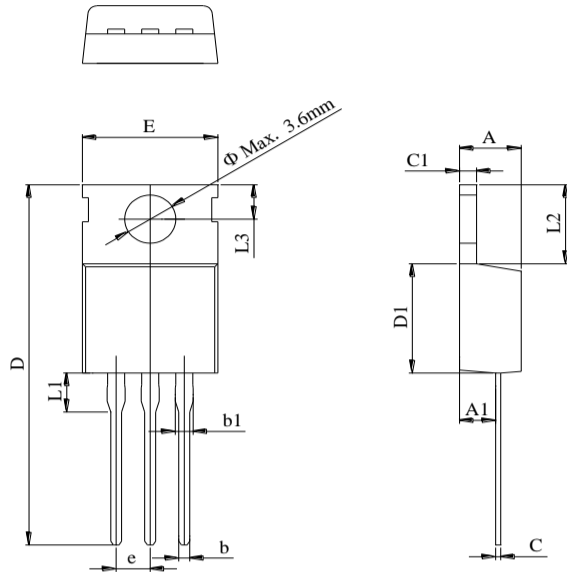

Figure 11: Normalized Maximum Transient Thermal Impedance

**TO-220-3L Package Information**

**Package Outline**



DIM.	MILLIMETER		
	MIN.	NOM.	MAX.
A	4.24		4.70
A1	2.20		3.00
b	0.70		0.95
b1	1.14		1.70
C	0.40		0.60
C1	1.15		1.40
D	28.00		29.80
D1	8.80		9.90
E	9.70		10.50
L1			3.80
L2	6.25		6.90
L3	2.40		3.00
e		2.54 BSC	

**TO-263-3L Package Information**

**Package Outline**

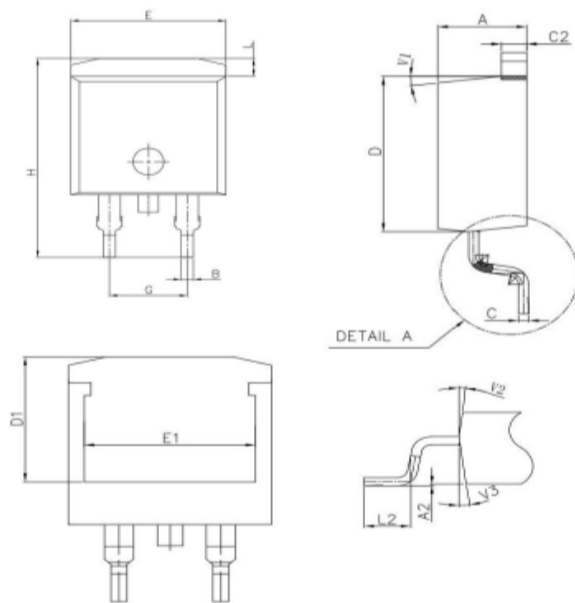

SYMBOL	DIMENSIONS		
	MIN	NOM	MAX
A	4.3	4.55	4.7
A2	0		0.25
B	0.75	0.8	0.85
C	0.38	0.46	0.55
C2	1.25	1.3	1.35
D	8.9	9.3	9.6
D1	7.4	7.65	7.9
E	9.9	10.05	10.21
E1	8.3	8.6	8.9
G	5.03	5.08	5.13
H	14.7	15	15.8
L2	2.2	2.35	2.5

**Recommended Footprint**

